

## TAURUS range keyless chucks

Designed to exceed the performance of conventional drill chucks, the TAURUS range, represents a revolutionary new concept in technology and are precision engineered to enable the operator to lock the bit firmly in the chuck by hand.

- Suitable for Forward, Reverse and Percussion
- Nylon and Full metal version
- Double and single sleeve suitable for conventional and spindle lock machines
- Antilock mechanism
- Standard and Carbide jaw bite
- High performance for machines up to **1100 Watts** impact applications

Model numbers ending in letter R indicate chuck supplied with through hole to accommodate a left hand locking screw for reversing tools.

A TORX® wrench can also be used to lock the keyless chucks to the drilling machine spindle. No left hand screw is needed in this case.

### TAURUS REGULAR

Hard nylon two piece sleeve, metal nose cap, suitable for machines in forward and reverse mode. Hand tightening style.

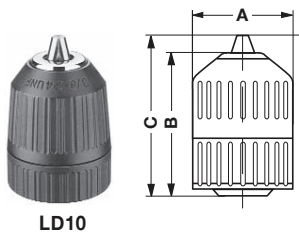

Model No.	Drilling capacity mm	Mount	A mm	B mm	C mm	Max machine rating	Packaging style	Weight g
LD10F12R	1.5-10	1/2" x 20	42.7	55	62	Suitable for machines in forward and reverse mode only	Individual box	182
LD10F12RB							Blister card	
LD10F38R		3/8" x 24					Individual box	
LD10F38RB							Blister card	

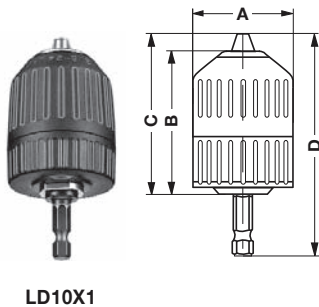

### KEYLESS CHUCKS FOR SCREWDRIVERS

with 1/4" male hexagonal mount to DIN 3126 - E 6.3.

Model No.	Drilling capacity mm	A mm	B mm	C mm	D mm	Packaging style	Weight g
LD10X1B	1.5-10	42.7	55	62	80	Individual box	200

### TAURUS PROFESSIONAL

Hard nylon two piece sleeve, metal nose cap, suitable for machines in forward, reverse and percussion mode. Hand tightening style.

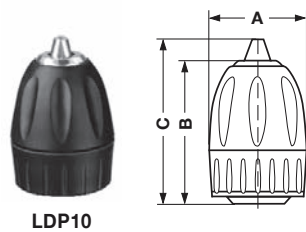

Model No.	Drilling capacity mm	Mount	A mm	B mm	C mm	Max machine rating	Packaging style	Weight g
LDP10F12R	1.5-10	1/2" x 20	42.7	55	63	450 W	Individual box	172
LDP10F12RB							Blister card	
LDP10F38R		3/8" x 24					Individual box	
LDP10F38RB							Blister card	

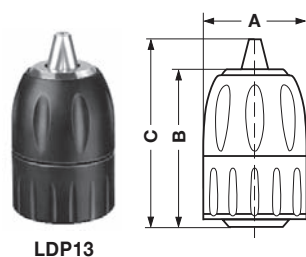

Model No.	Drilling capacity mm	Mount	A mm	B mm	C mm	Max machine rating	Packaging style	Weight g	
LDP13F12R	2-13	1/2" x 20	42.7	62	76	710 W	Individual box	290	
LDP13F12RB							Blister card		
LDP13F38R		3/8" x 24					Individual box		
LDP13F38RB							Blister card		
LDP13SDS		SDS					Individual box		330
LDP13SDSB							Blister card		



LDP10SQ

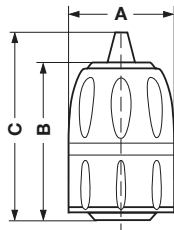

### TAURUS PROFESSIONAL - SPINDLE LOCK SYSTEM

For machines with Spindle Lock system. Hard nylon single sleeve suitable for forward, reverse and percussion mode.

Model No.	Drilling capacity mm	Mount	A mm	B mm	C mm	Max machine rating	Packaging style	Weight g
LDP10SQ38	2-13	1/2" x 20	42.7	62	73	710 W	Individual box	280
LDP10SQ12							Blister card	



TSP10

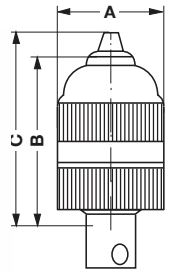

### TAURUS PROFESSIONAL - FOR IMPACT DRIVERS

Model No.	Drilling capacity mm	Mount	A mm	B mm	C mm	Max torque	Packaging style	Weight g
LDP10SQ38	1-10	Quadro 3/8"	41	77	85	100 Nm	Individual box	232
LDP10SQ12		Quadro 1/2"	41	80	88			263

**TAURUS SUPER** suitable for forward, reverse and impact mode. standard jaws with serrated bite.

Hard nylon two piece sleeve



TSMP10

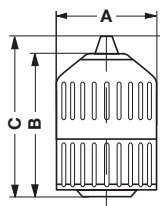

Model No.	Drilling capacity mm	Mount	A mm	B mm	C mm	Max machine rating	Packaging style	Weight g
TSP10F12R	1.5-10	1/2" x 20	42.7	55	64	1100 W	Individual box	165
TSP10F12RB							Blister card	
TSP10F38R		3/8" x 24					Individual box	
TSP10F38RB							Blister card	

Hard nylon front sleeve and rear metal sleeve



TSMP10

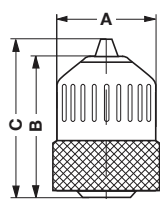

Model No.	Drilling capacity mm	Mount	A mm	B mm	C mm	Max machine rating	Packaging style	Weight g
TSMP10F12R	1.5-10	1/2" x 20	42.7	55	64	1100 W	Individual box	195
TSMP10F12RB							Blister card	
TSMP10F38R		3/8" x 24					Individual box	
TSMP10F38RB							Blister card	



TSP13

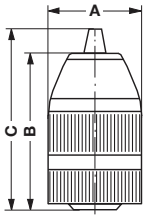

Hard nylon two piece sleeve

Model No.	Drilling capacity mm	Mount	A mm	B mm	C mm	Max machine rating	Packaging style	Weight g
TSP13F12R	1.5-13	1/2" x 20	42.7	64	75.3	1100 W	Individual box	260
TSP13F12RB							Blister card	



TS13

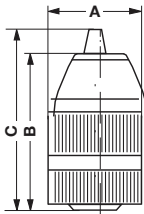

Full metal two piece sleeve

Model No.	Drilling capacity mm	Mount	A mm	B mm	C mm	Max machine rating	Packaging style	Weight g
TS13F12R	1.5-13	1/2" x 20	42.7	64	75.3	1100 W	Individual box	295
TS13F12RB							Blister card	
TS13F38R		3/8" x 24					Individual box	
TS13F38RB							Blister card	
TS13SDS		SDS					Individual box	
TS13SDSB							Blister card	

**TAURUS SUPER - SPINDLE LOCK SYSTEM**

For machines with Spindle Lock system, suitable for forward, reverse and impact mode. Standard jaws with serrated bite.



TSSP10

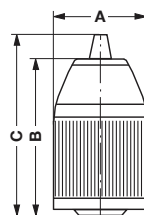

Hard nylon single sleeve

Model No.	Drilling capacity mm	Mount	A mm	B mm	C mm	Max machine rating	Packaging style	Weight g
TSSP10F12R	1.5-10	1/2" x 20	42.7	57.5	64	1100 W	Individual box	161
TSSP10F12RB							Blister card	
TSSP10F38R		3/8" x 24					Individual box	
TSSP10F38RB							Blister card	



TSS13

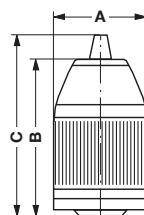

Full metal single sleeve

Model No.	Drilling capacity mm	Mount	A mm	B mm	C mm	Max machine rating	Packaging style	Weight g
TSS13F12R	1.5-13	1/2" x 20	42.7	64	75.3	1100 W	Individual box	295
TSS13F12RB							Blister card	



## TAURUS ULTIMATE

Suitable for forward, reverse and impact mode.  
Carbide jaw bite to ensure better gripping.

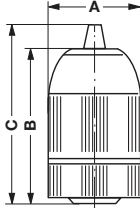

TUP13

Hard nylon two piece sleeve

Model No.	Drilling capacity mm	Mount	A mm	B mm	C mm	Max machine rating	Packaging style	Weight g
TUP13F12R TUP13F12RB	1.5-13	1/2" x 20	42.7	63.5	75.3	1100 W	Individual box Blister card	248

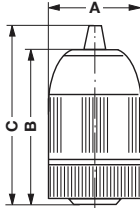

TUMP13

Hard nylon front sleeve and rear metal sleeve

Model No.	Drilling capacity mm	Mount	A mm	B mm	C mm	Max machine rating	Packaging style	Weight g
TUMP13F12R TUMP13F12RB	1.5-13	1/2" x 20	42.7	63.5	75.3	1100 W	Individual box Blister card	282

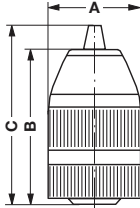

TU13

Full metal two piece sleeve

Model No.	Drilling capacity mm	Mount	A mm	B mm	C mm	Max machine rating	Packaging style	Weight g
TU13F12R TU13F12RB	1.5-13	1/2" x 20	42.7	63.5	75.3	1100 W	Individual box Blister card	282

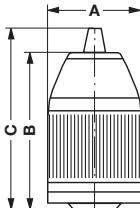

TUS13

## TAURUS ULTIMATE - SPINDLE LOCK SYSTEM

For machines with Spindle Lock system, suitable for forward, reverse and impact mode. Carbide jaws.

Model No.	Drilling capacity mm	Mount	A mm	B mm	C mm	Max machine rating	Packaging style	Weight g
TUS13F12R TUS13F12RB	1.5-13	1/2" x 20	42.7	64	75.3	1100 W	Individual box Blister card	295